

Good for Elevator, Good for Human

FIRSTONE

ELEVATOR

TOTAL COLLECTION

MECHANICAL COMPONENTS
ELECTRONIC COMPONENTS
ESCALATOR

FIRSTONE
퍼스트원

Brake Housing 001

Brake Contact Switch 002

Brake Housing 003

Brake Housing 004

Brake Coil 005

Brake Plunger Bolt 006

Brake Plunger 007

Brake Plunger 008

Brake Plunger 009

Bronze Washer 010

Bronze Washer 011

Brake Shoe 012

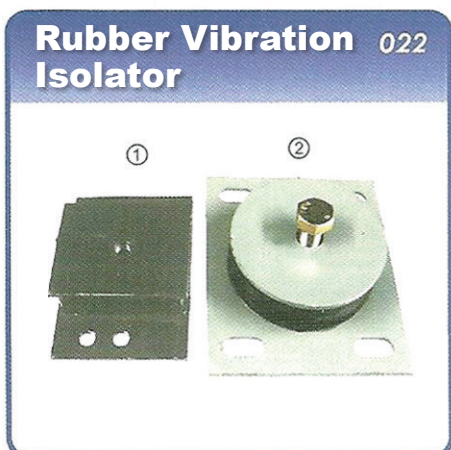
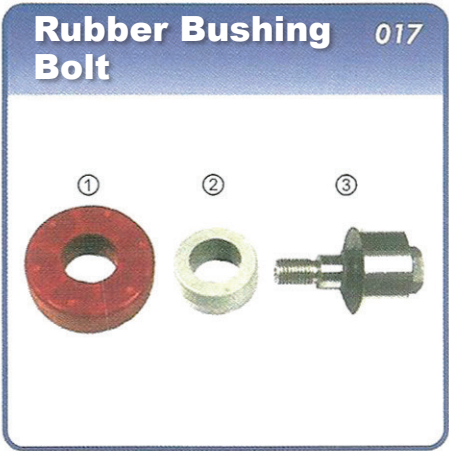

Guide Roller

025

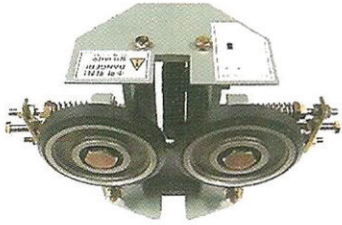

Guide Roller

026

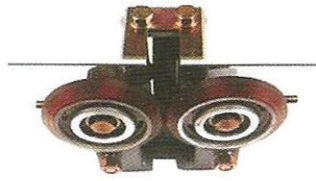

Guide Roller

027

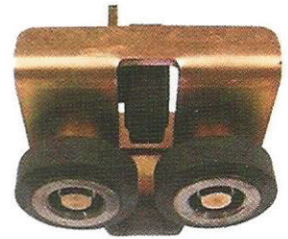

Guide Roller

028

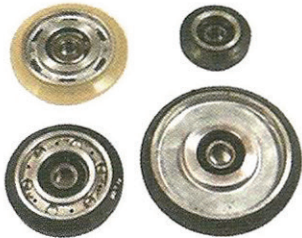

Guide Shoe

029

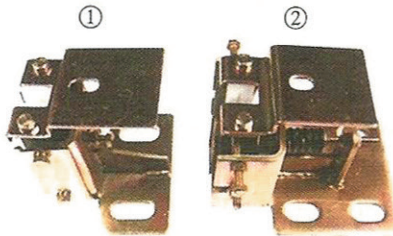

Guide Shoe

030

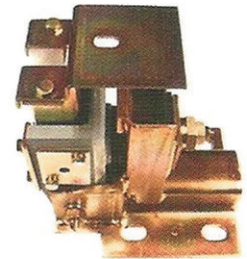

Guide Shoe

031

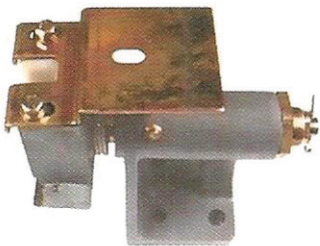

Guide Shoe

032

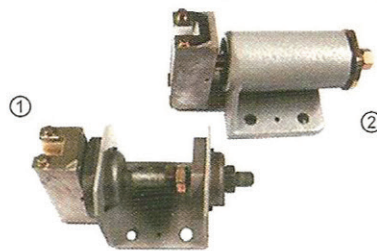

Guide Shoe

033

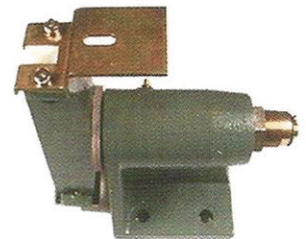

Guide Shoe

034

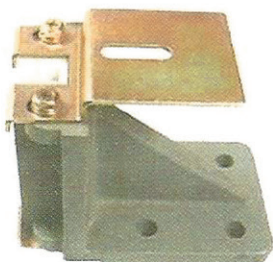

Guide Shoe

035

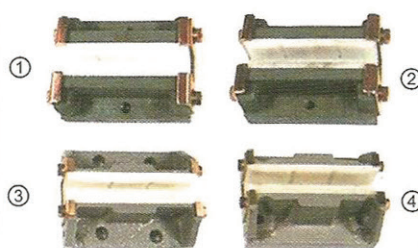

Guide Shoe

036

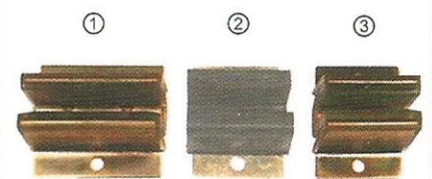

Guide Shoe Line 037

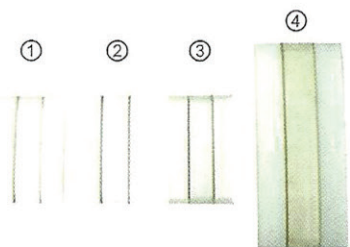

Guide Shoe Line 038

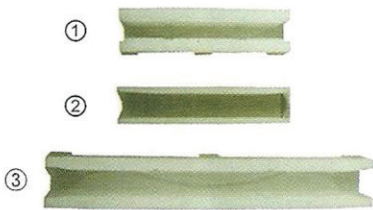

Oiler 039

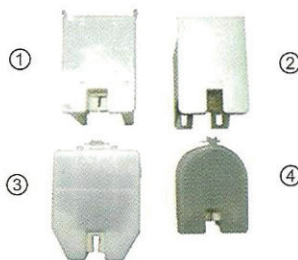

Fan 040

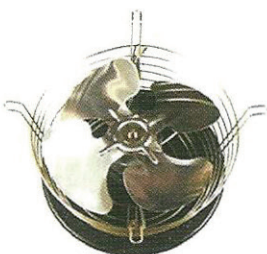

Fan 041

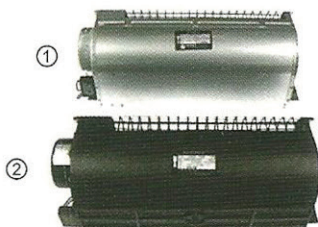

Fan 042

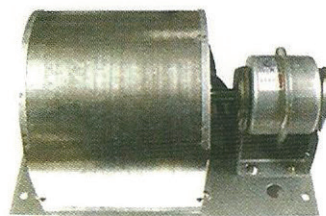

Rubber Vibration Isolator 043

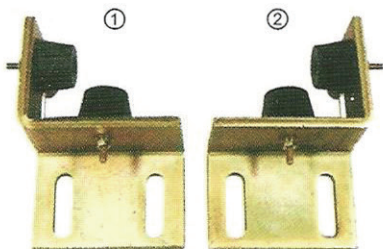

Rubber Vibration Isolator 044

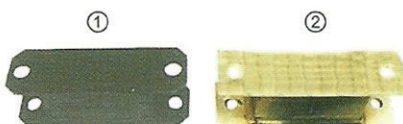

Door Motor 045

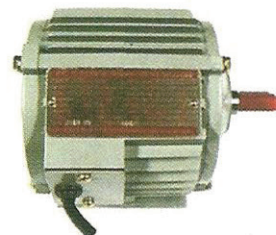

Door Motor 046

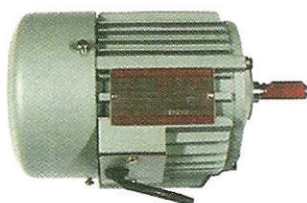

Door Motor 047



Door Motor 048

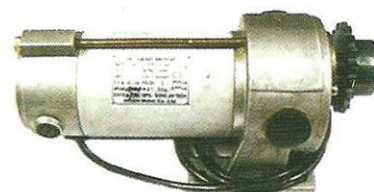

Car Door

049

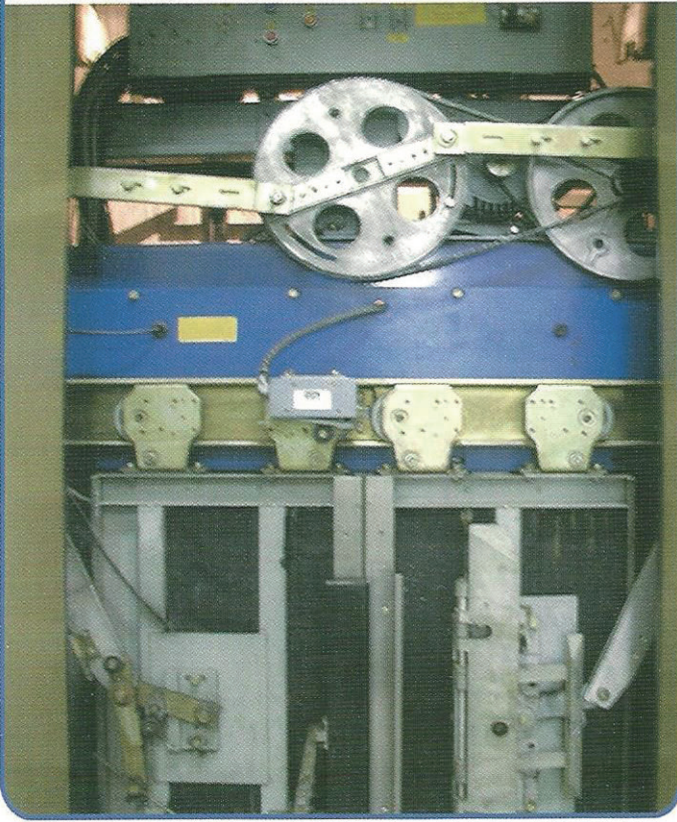

Car Door

050

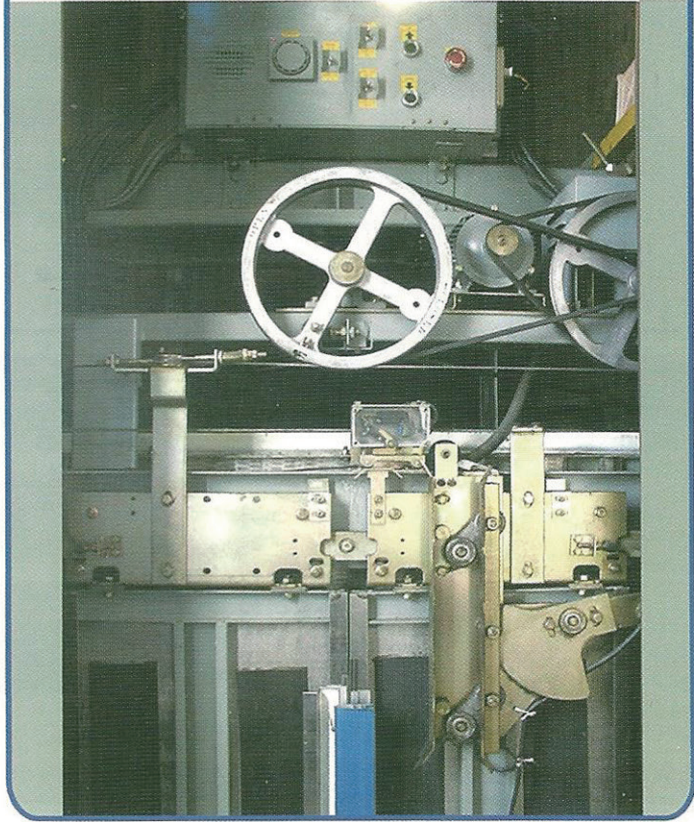

Car Door

051

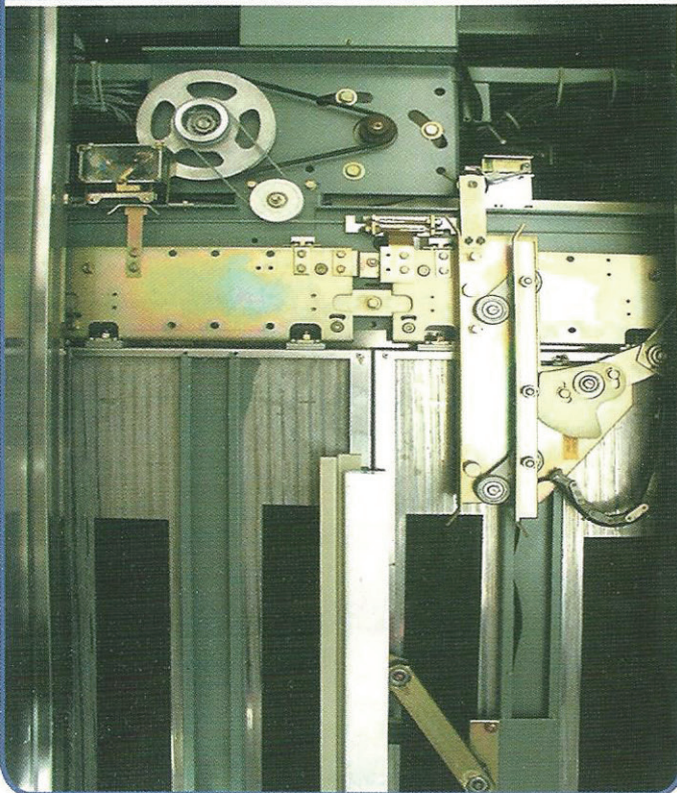

Car Door

052

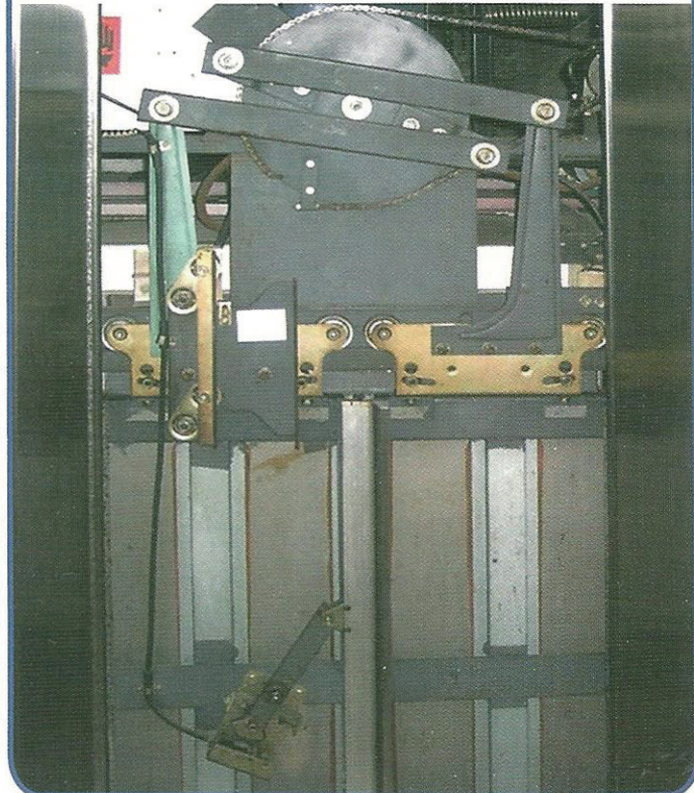

Car Door

053

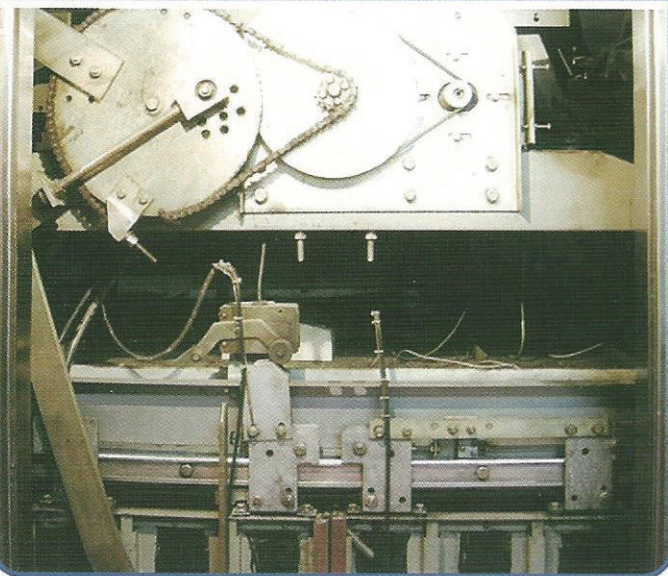

Car Door

054



Car Door

055

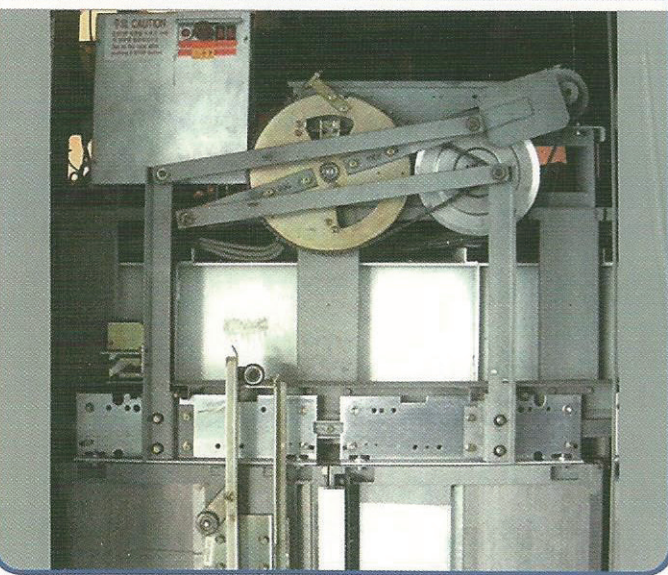

Car Door

056

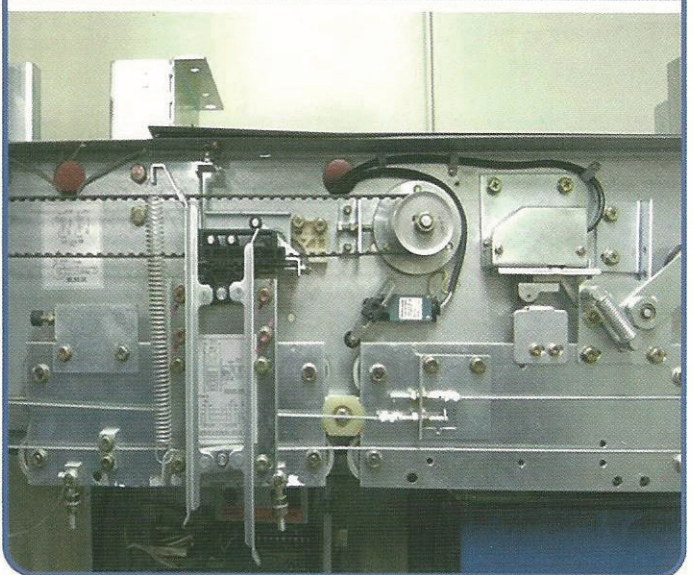

Hatch Door Hanger⁰⁵⁷

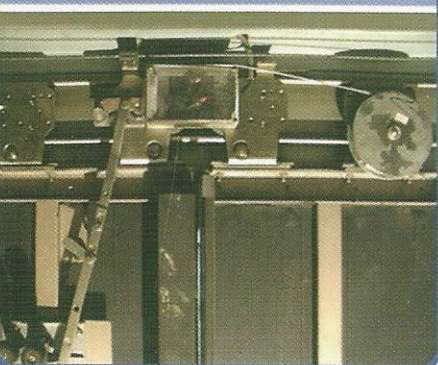

Hatch Door Hanger⁰⁵⁸

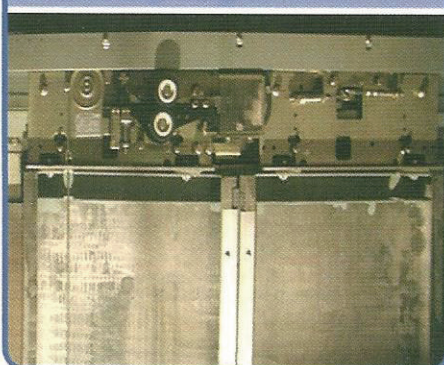

Hatch Door Hanger⁰⁵⁹

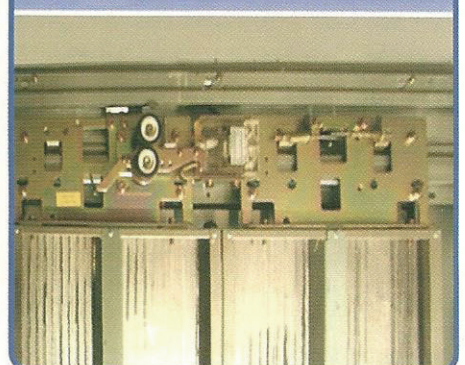

Hatch Door Hanger ⁰⁶⁰

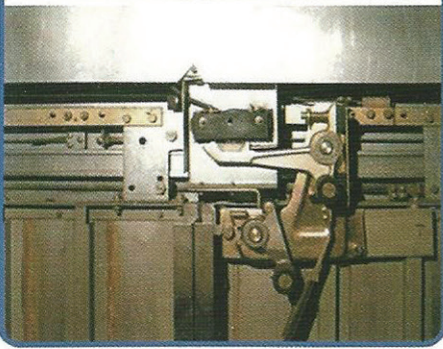

Hatch Door Hanger ⁰⁶¹

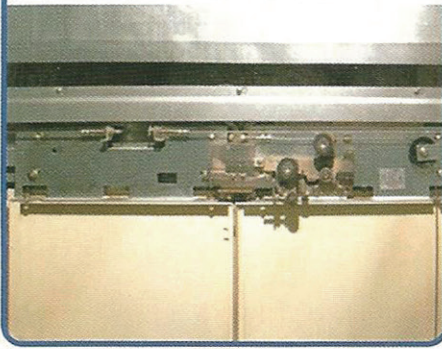

Hatch Door Hanger ⁰⁶²

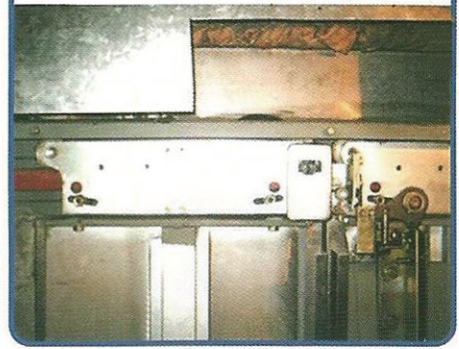

Hatch Door Hanger ⁰⁶³

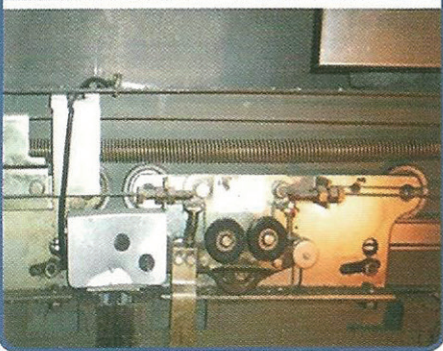

Hatch Door Hanger ⁰⁶⁴

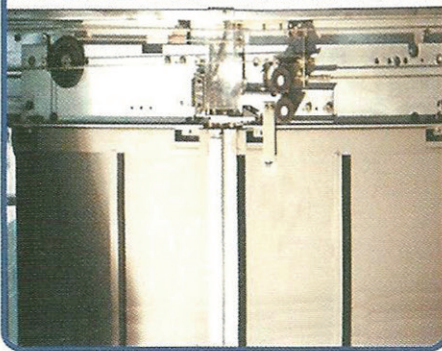

Door Motor ⁰⁶⁵

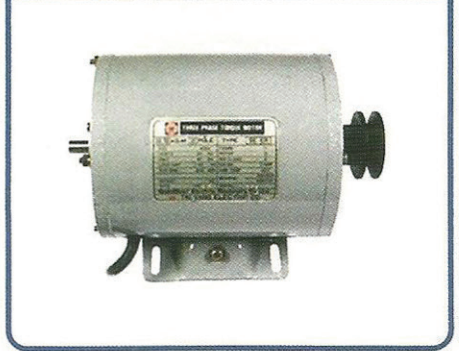

Door Motor ⁰⁶⁶



Door Motor ⁰⁶⁷



Coupling ⁰⁶⁸

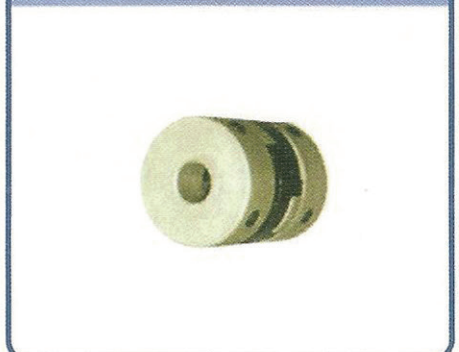

Door Pulley ⁰⁶⁹

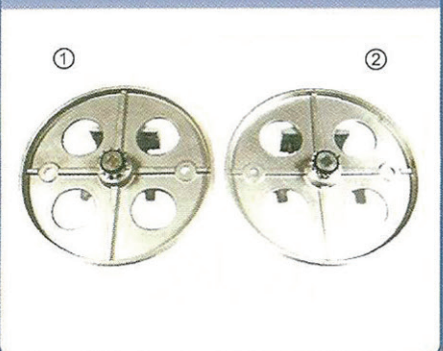

Chain Pulley ⁰⁷⁰

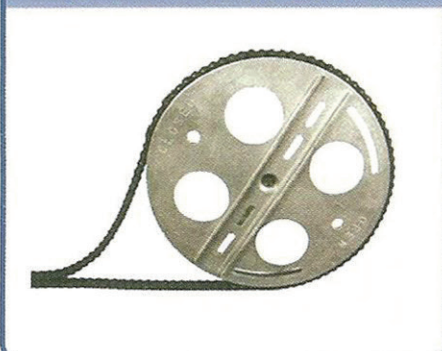

Door Pulley ⁰⁷¹

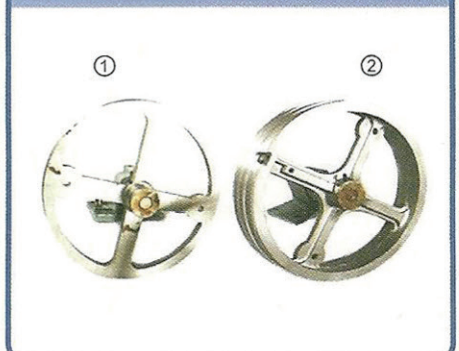

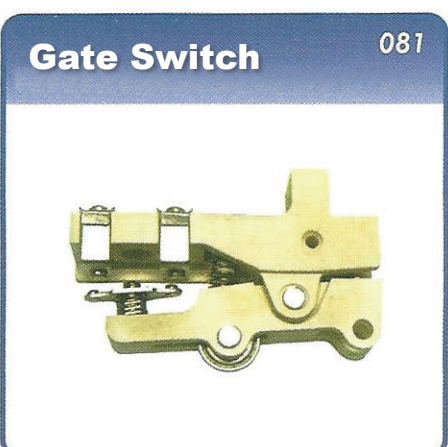
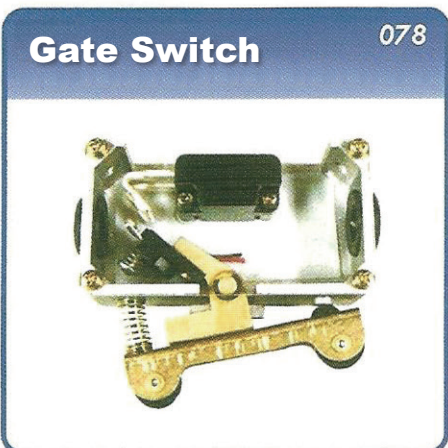
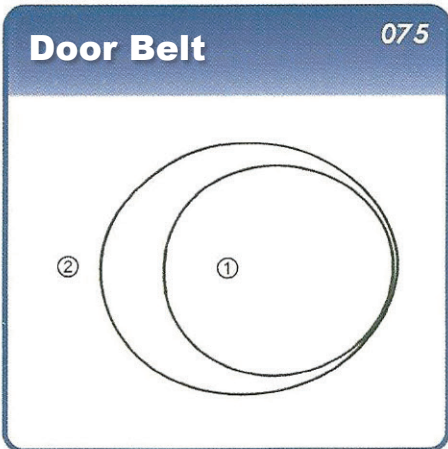
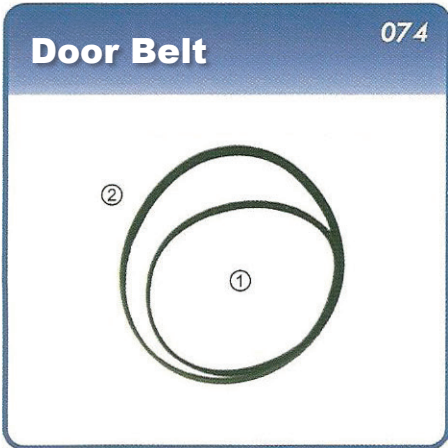
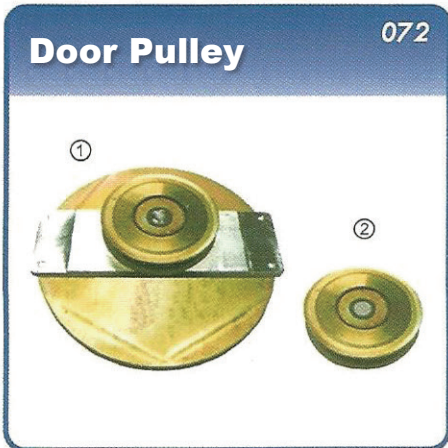

Car Door Clutch

084

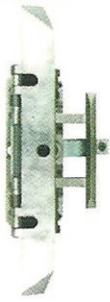

Adjustment Plate & Roller

085

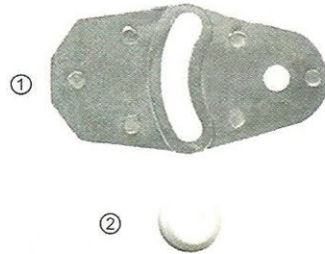

Car Door Clutch

086

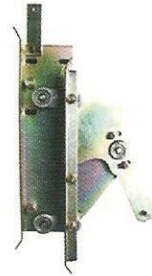

Car Door Clutch

087

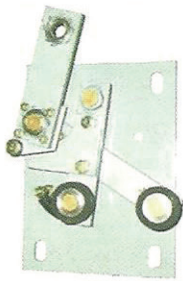

Gripper

088

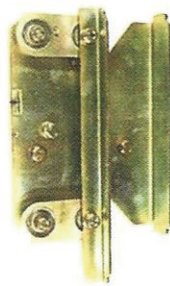

Car Door Clutch

089

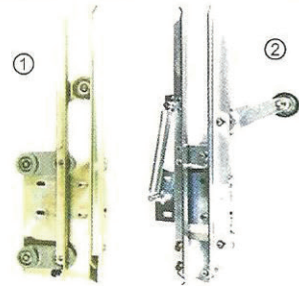

Coupler

090



Door Link Set

091



Crank Arm

092

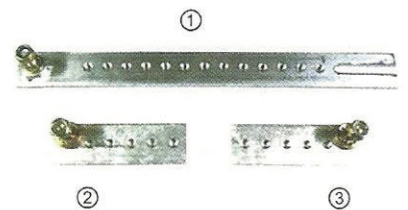

Safety Shoe

093



Safety Shoe

094



Key Set

095

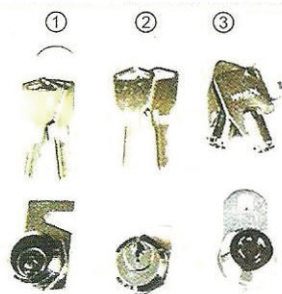

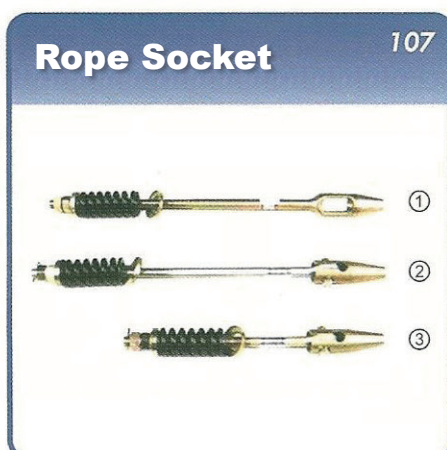
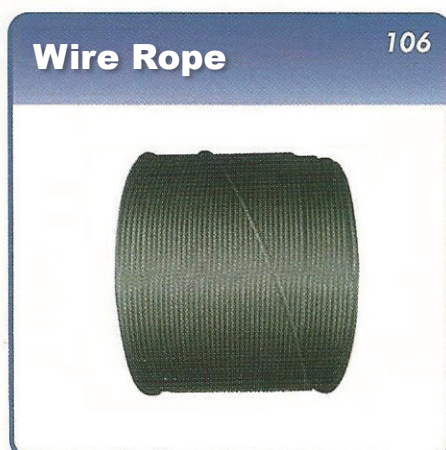
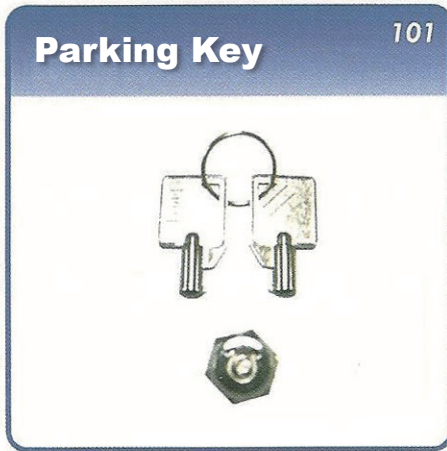
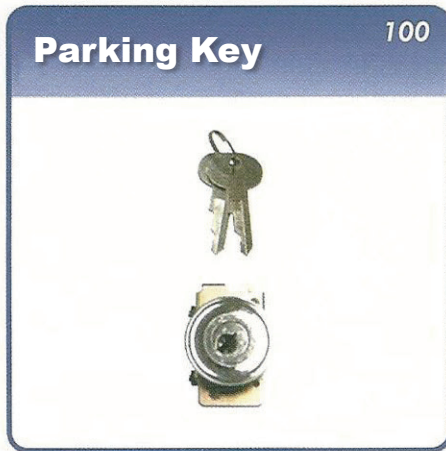
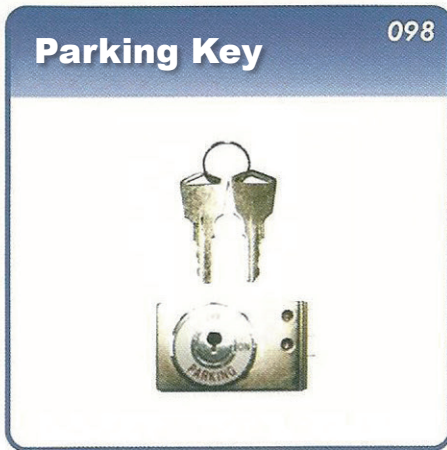

Rope Scket

108



Vibrating Weight

109



Babette

110

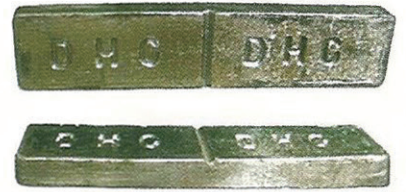

Steel Tape

111



Landing Control System

112

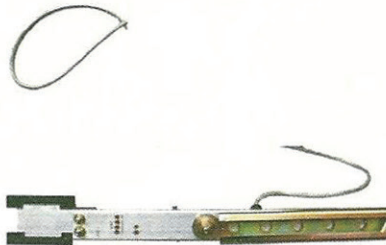

L.C.S Guide Shoe

113

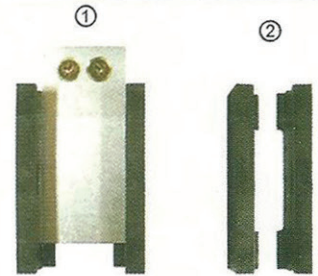

Tension Sheave

114



Tension Sheave

115

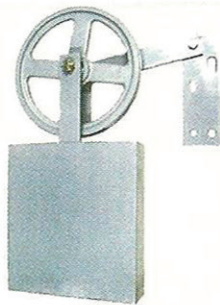

Balance Chain

116

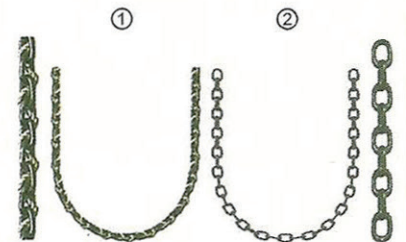

Rail Oil Receiver

117

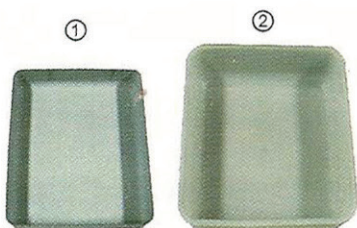

Spring Buffer

118



Pit Switch

119



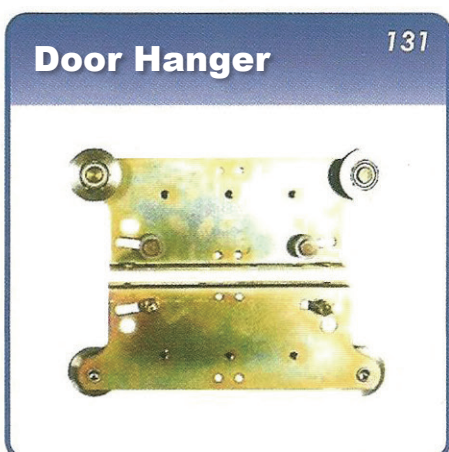
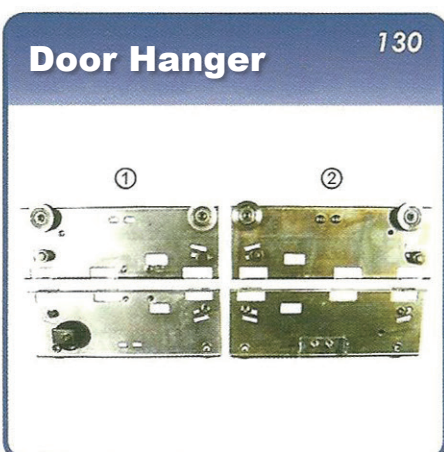
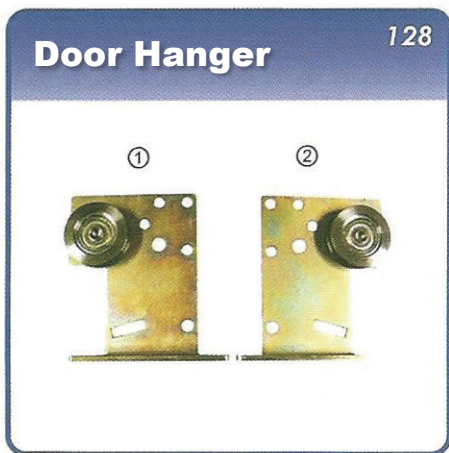
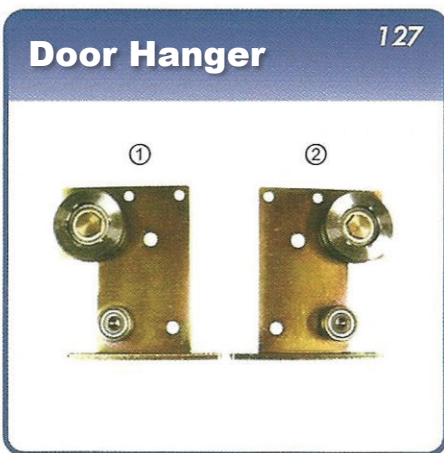
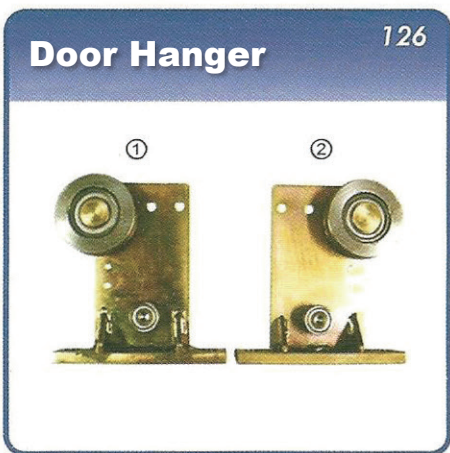
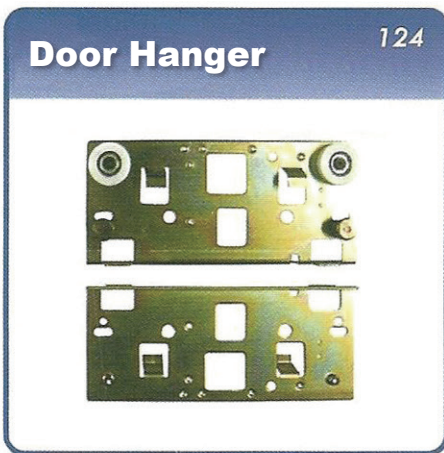
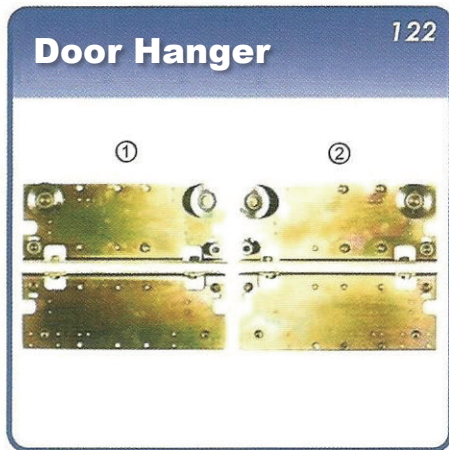
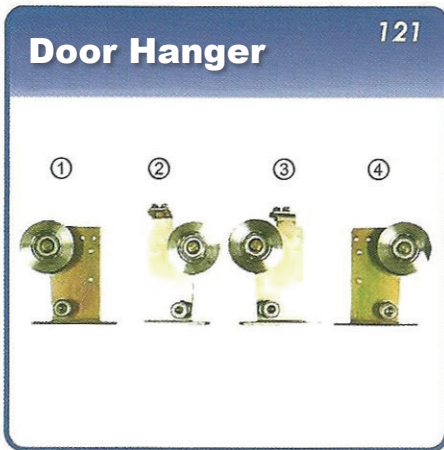
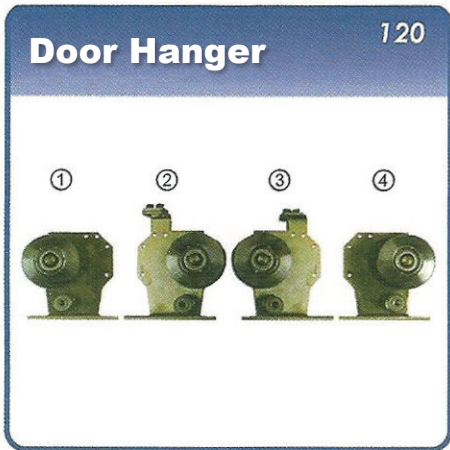

Door Hanger

132

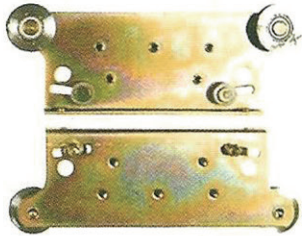

Door Hanger

133

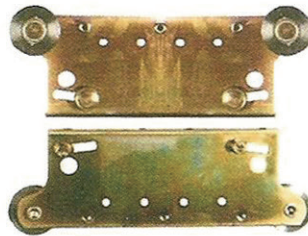

Door Hanger

134

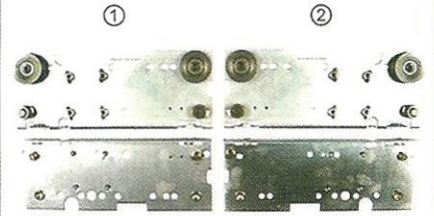

Door Hanger

135

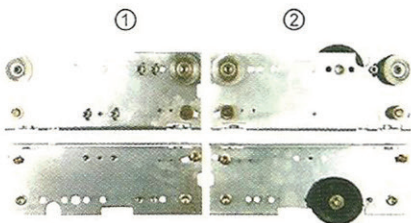

Door Hanger

136

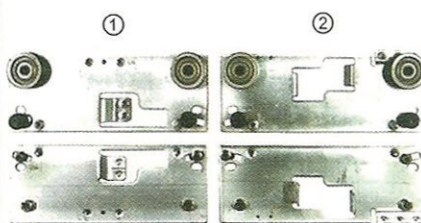

Door Hanger

137

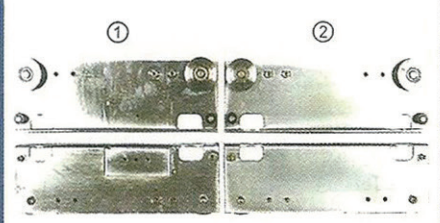

Door Hanger

138

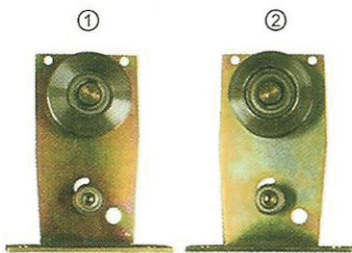

Door Hanger

139

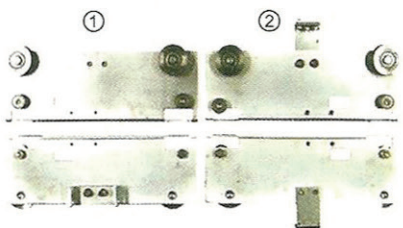

Door Hanger

140

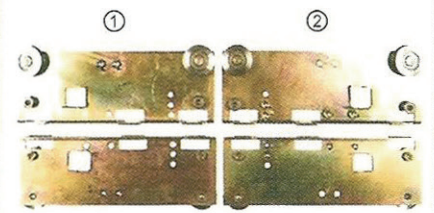

Accents Roller

141



Accents Roller

142



Accents Roller

143



Accents Roller 144

This image shows four different types of accents rollers. Two are labeled '1' and two are labeled '2'. They vary in material (some are brass, some are black) and design (some have a central screw, some are flat).

Accents Roller 145

This image shows four different types of accents rollers. Two are labeled '1' and two are labeled '2'. They vary in material and design, including some with a central screw and some with a flat top.

Interlocking Rope Pulley 146

This image shows two interlocking rope pulleys. One is labeled '1' and the other is labeled '2'. They are made of brass and have a complex, interlocking design with a central axle.

Interlocking Rope Pulley 147

This image shows two interlocking rope pulleys. One is labeled '1' and the other is labeled '2'. They are made of brass and have a simple, circular design with a central axle.

Interlocking Rope Pulley 148

This image shows two interlocking rope pulleys. One is labeled '1' and the other is labeled '2'. They are made of brass and have a simple, circular design with a central axle.

Interlocking Rope Pulley 149

This image shows four interlocking rope pulleys. Two are labeled '1' and two are labeled '2'. They vary in material and design, including some with a central axle and some without.

Interlocking Rope Pulley 150

This image shows four interlocking rope pulleys. Two are labeled '1' and two are labeled '2'. They vary in material and design, including some with a central axle and some without.

Interlocking Rope Pulley 151

This image shows four interlocking rope pulleys. Two are labeled '1' and two are labeled '2'. They vary in material and design, including some with a central axle and some without.

Chain Roller 152

This image shows four chain rollers. Two are labeled '1' and two are labeled '2'. They vary in material and design, including some with a central axle and some without.

Spirator 153

This image shows a single spirator component. It is a circular, dark-colored metal part with a central hole and a small protrusion.

Door Rope 154

This image shows two door ropes. One is labeled '1' and the other is labeled '2'. They are made of metal and have a circular shape with a central hole.

Door Rope 155

This image shows three door ropes. One is labeled '1' and two are labeled '2'. They vary in material and design, including some with a central hole and some without.

Weight Spring

156



Interlock

157

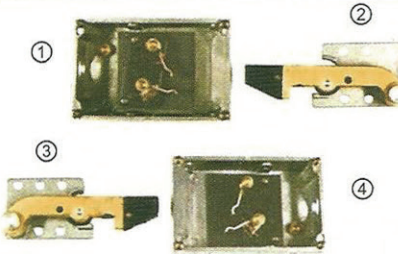

Release Base

158

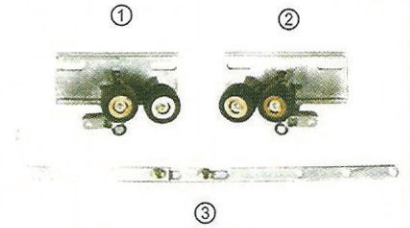

Interlock

159

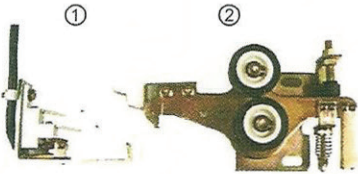

Interlock

160

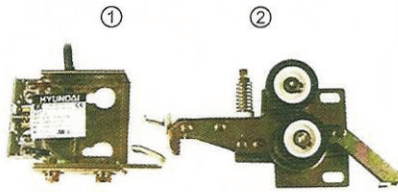

Interlock

161

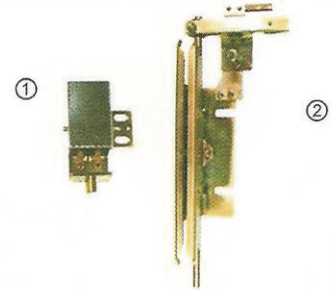

Interlock

162

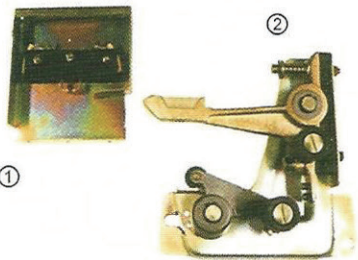

Interlock

163

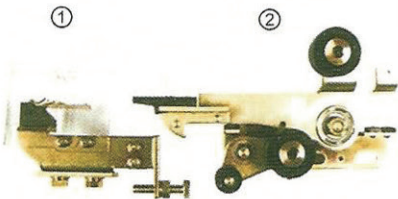

Interlock

164

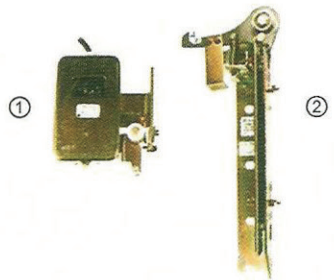

Interlock

165

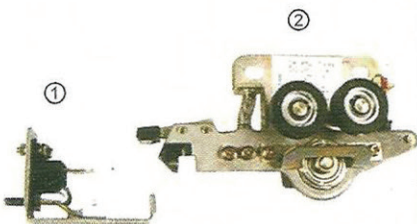

Interlock

166

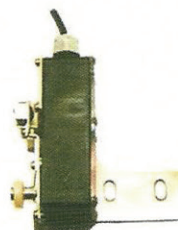

Interlock

167

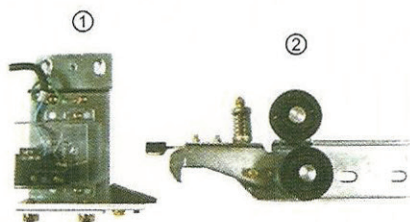

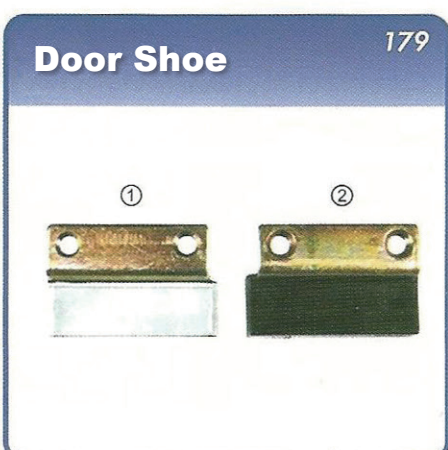
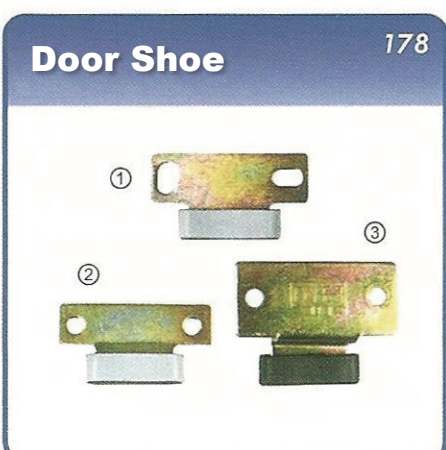
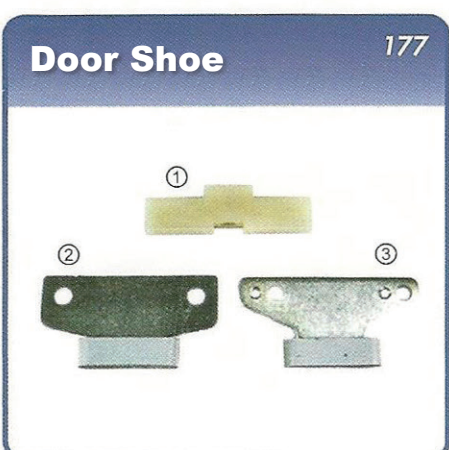
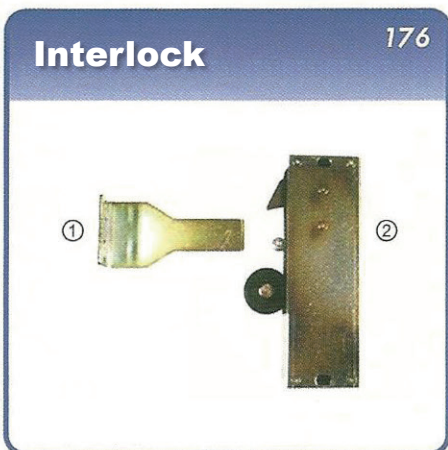
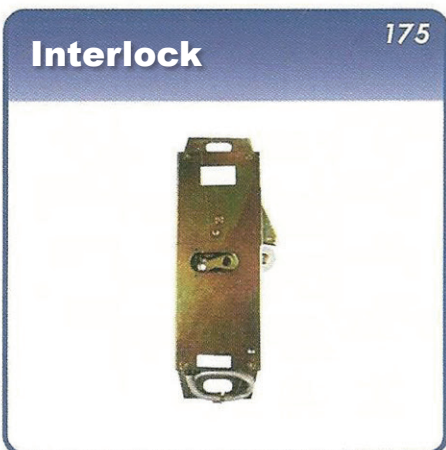
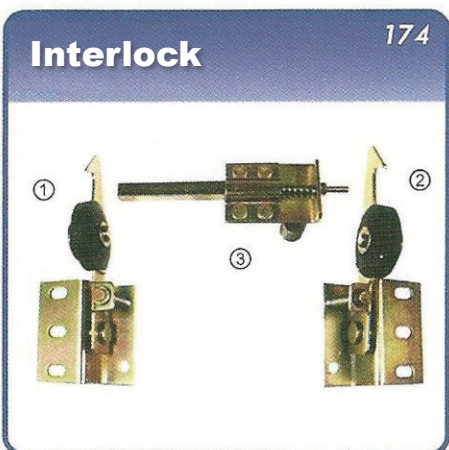
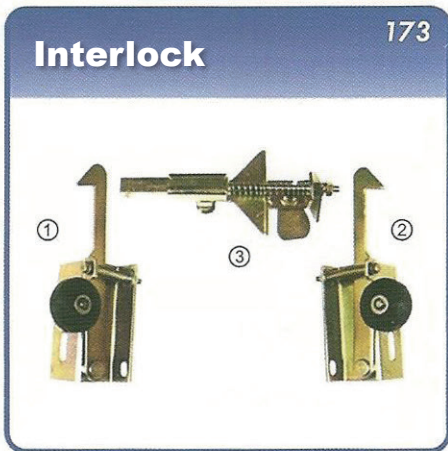
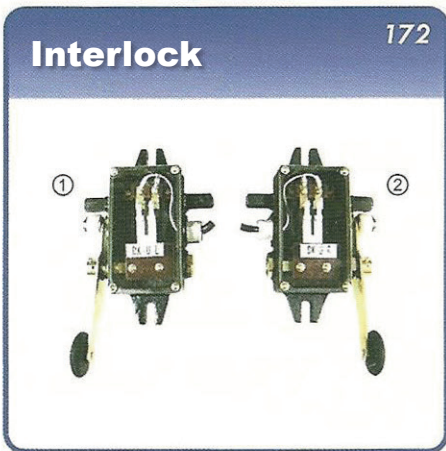
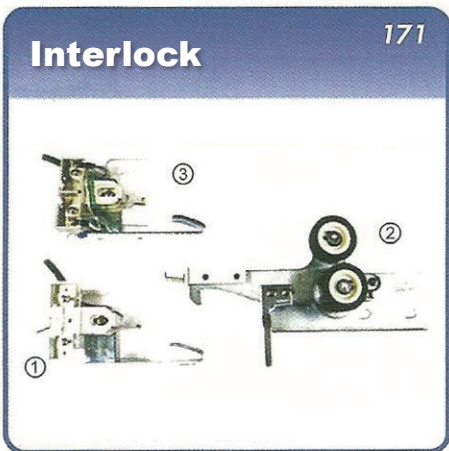
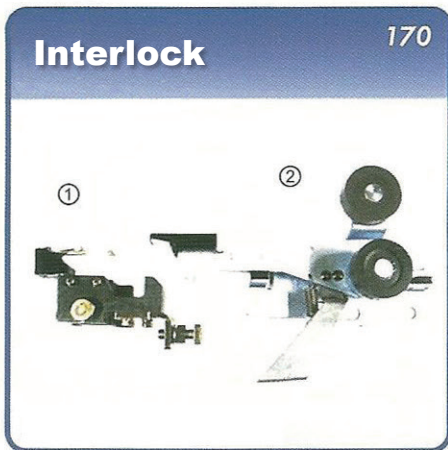
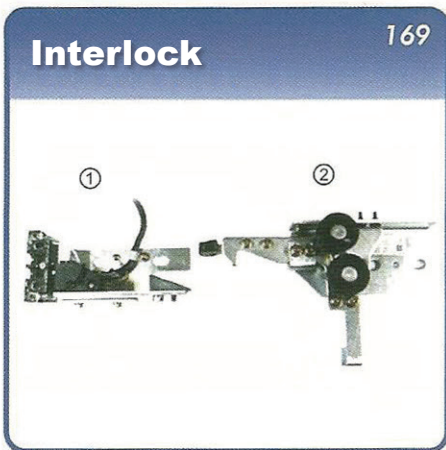
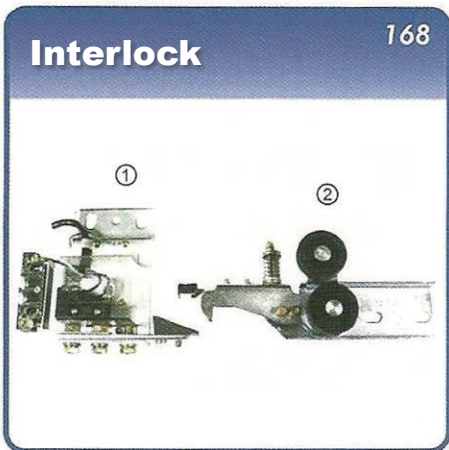

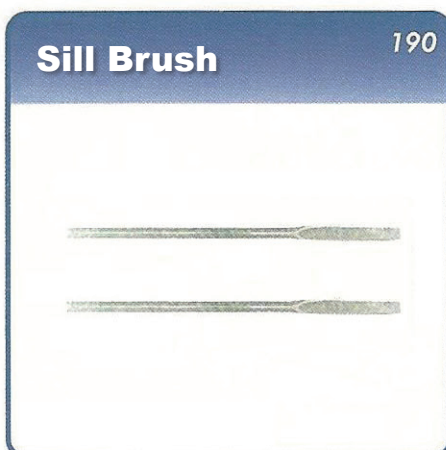
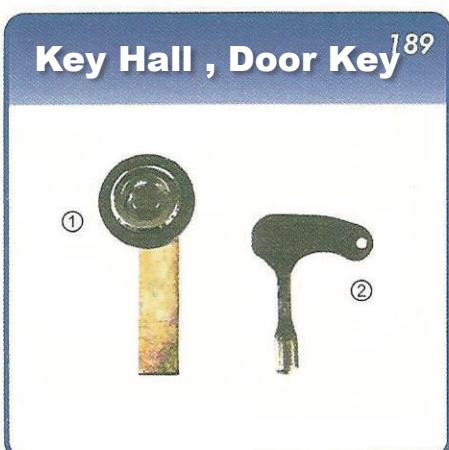
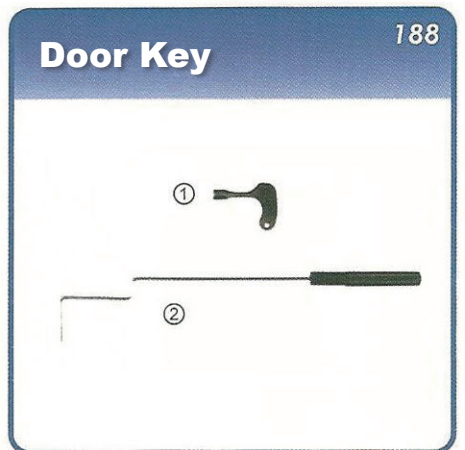
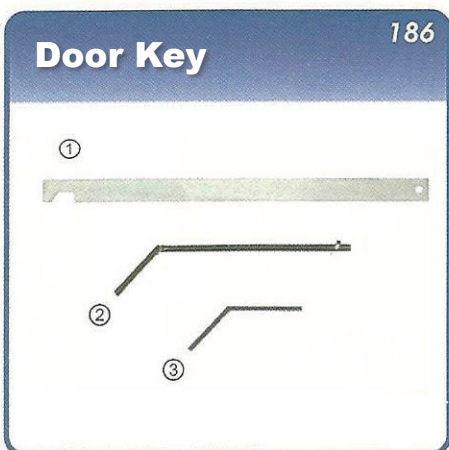
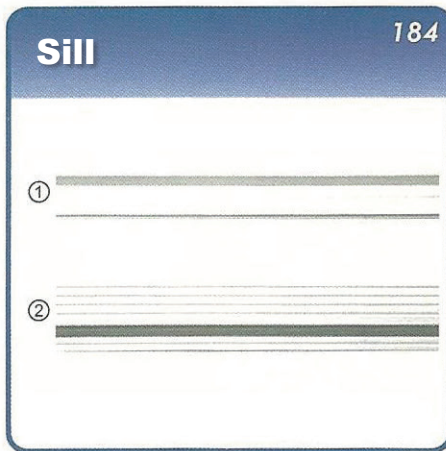
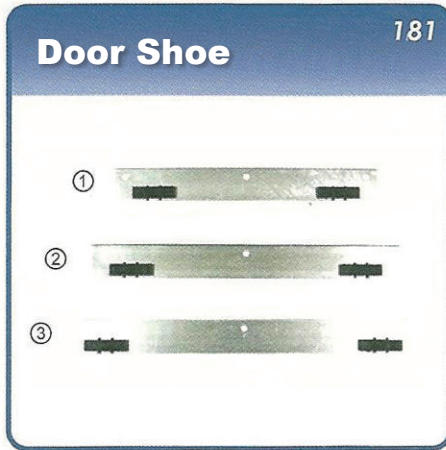
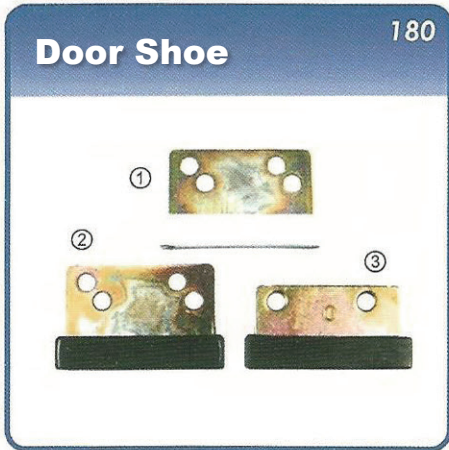

Rotary Encoder

192



Rotary Encoder

193



PG

194

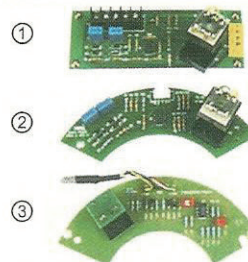

Pulse Tacho

195



Copper

196



Copper

197

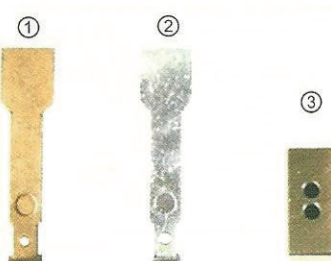

Copper

198

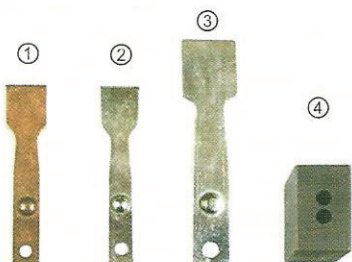

Copper

199

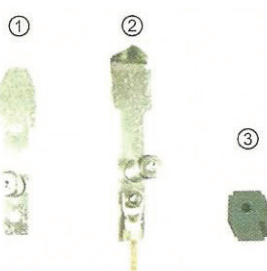

Copper

200

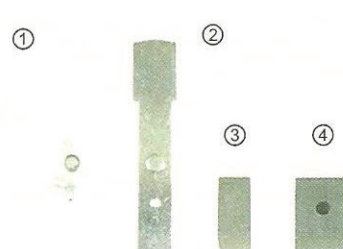

Selector

201



Finger

202

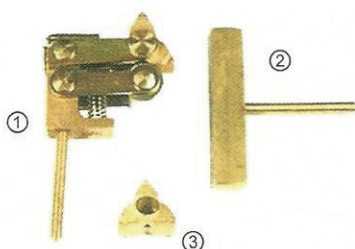

Power Supply

203

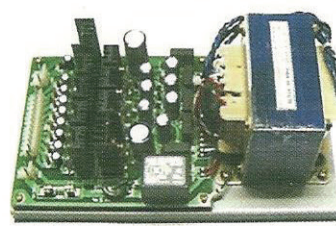

Power Supply

204



Door Timer

205

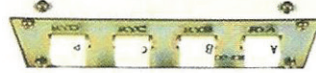

Reverse Phase Prevention Device

206

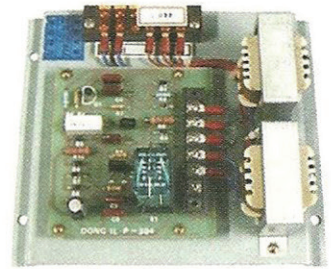

Reverse Phase Prevention Device

207



Matrix

208

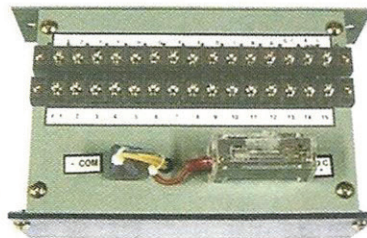

Fan

209



Module

210

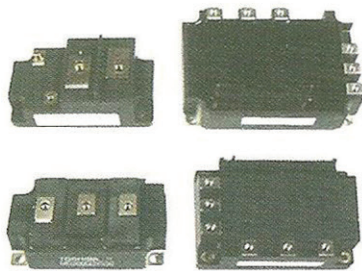

Interphone

211

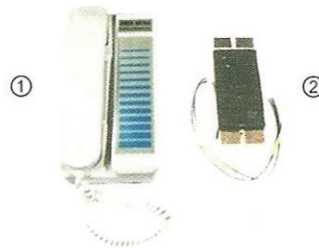

Interphone

212

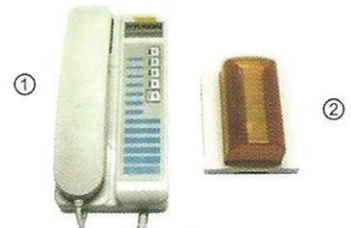

Interphone

213



Interphone

214

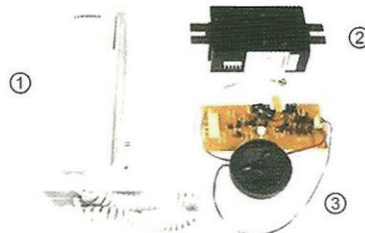

Interphone Power Supply

215

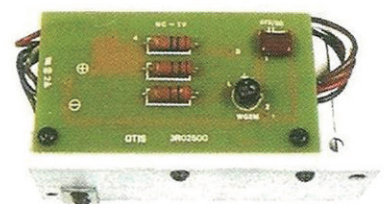

Gong

216



Buzzer

217

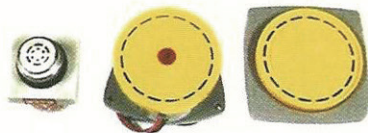

Electric Chime

218

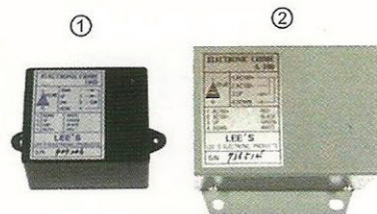

Electric Chime

219

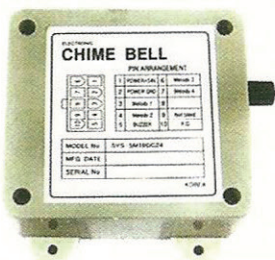

Inductor

220



Inductor

221

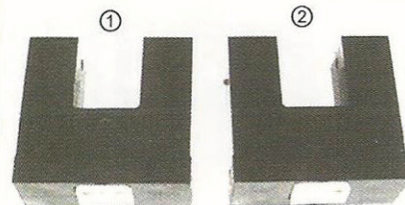

Inductor

222

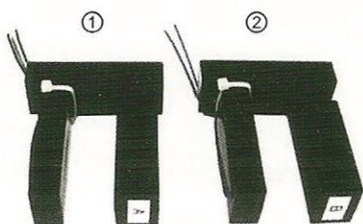

Landing Switch

223

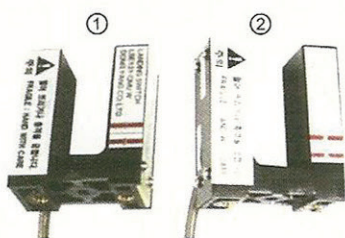

Posi

224

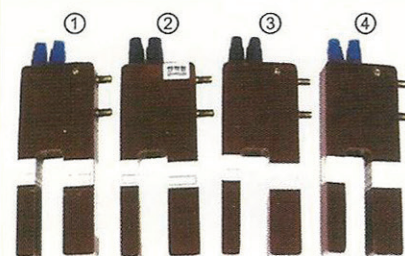

Inductor

225

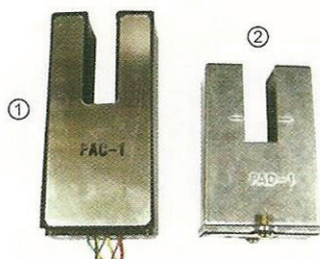

Inductor

226



Inductor

227

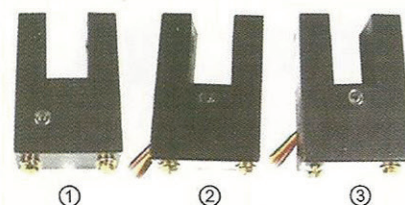

Emergency Power 228

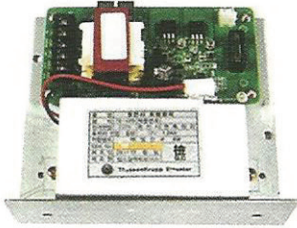

Emergency Power 229

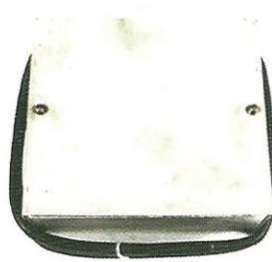

Emergency Power 230



Emergency Power 231

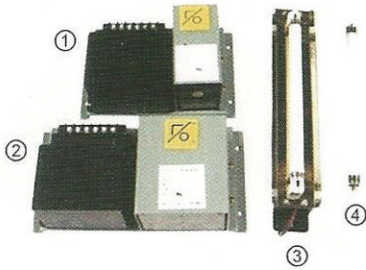

Battery 232



Battery 233

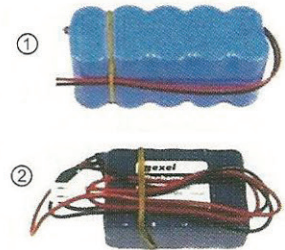

Cam Box 234

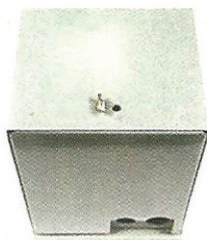

Cam Switch 235

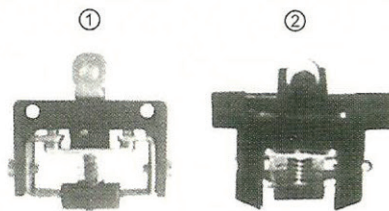

Cam Switch 236

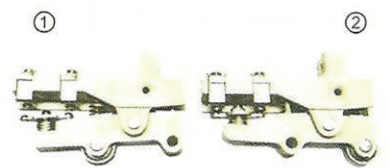

Micro Switch 237

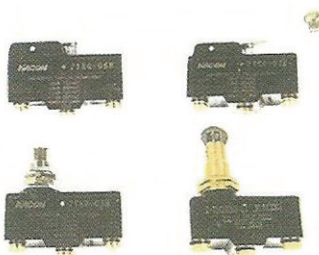
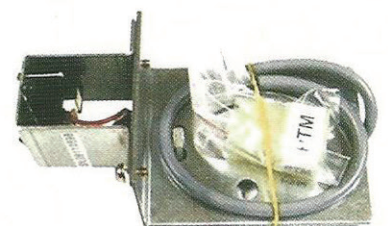

Photo Sensor 238



PTM 239



Traveling Cable 240



Limit Switch 241

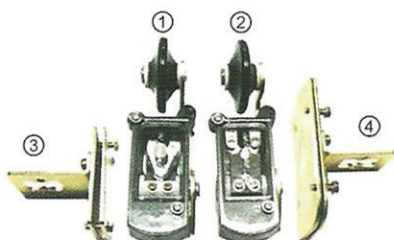

Limit Switch 242

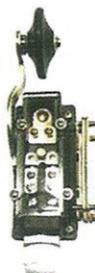

Limit Switch 243

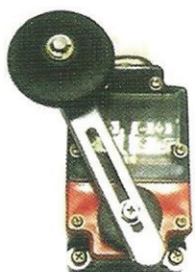

Limit Switch 244

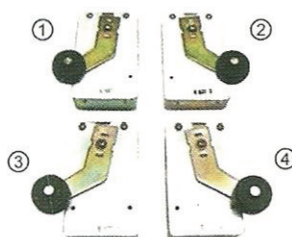

Limit Switch 245

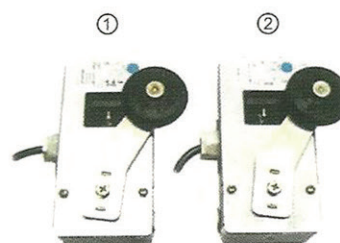

Change Over Switch 246

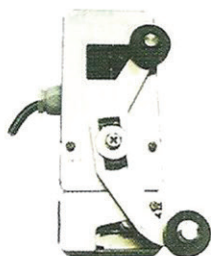

Button 247

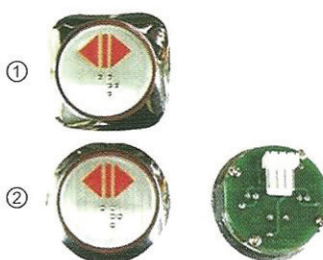

Button 248

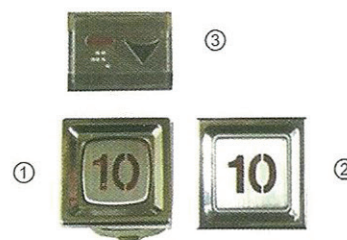

Button 249

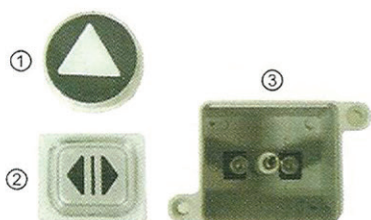

Button 250

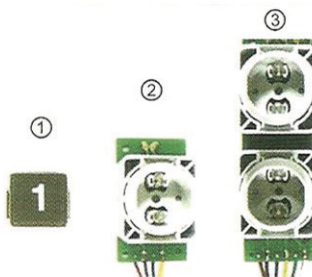

Button 251

